

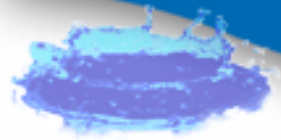

Inland Empire
UTILITIES AGENCY*
*A Municipal Water District



Clean, inexpensive, plentiful water

Recycled Water Rate Update

Regional Technical Committee

January 7, 2010



Clean, inexpensive, plentiful water

Initial Three Year Business Plan Assumptions, (Dec 2007):

- ***New Water Supply*** – 37,000 AFY for a total of 50,000 AFY
- ***Self funded at 50,000 AFY***- through recycled water sales (\$4M) and MWD LPP and LRP rebates(\$6M).
- ***Total Revenues*** – approximately \$10M per year including sales (\$4M) and MWD rebates (\$6M).
- ***Total expenses*** – approximately \$10M per year (\$6M debt service + \$4M O&M)

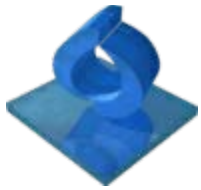

Status Update: RW Capital Projects Summary

	Project Name	Aug 2008 Cost Estimate (Millions)	Current Cost Estimate (Millions)
Approved Projects	Northeast Area	\$ 44	\$28
	Northwest Area	40	27 – 31
	Priority Projects	0	4 – 22
	Sub Total	\$84	\$59 - \$81
Planning Projects	Southern Area	29	11 – 18
	Central Area (Wineville Extension)	\$ 8	\$13 - 15.5
	Heritage Village Lateral	4	4
	Baseline Regional – Phase I	4	4
	Baseline Regional Phase II	19	15 - 19
	Sub Total	\$ 35	\$ 36 – \$42.5
	TOTAL	\$ 119	\$95 – \$123.5



Clean, inexpensive, plentiful water

KEY New Issues:

- MWD water rates increasing much faster (50+%) than assumed a few years ago
- IEUA recycled water debt service significantly lower because of Fed/State grants and SRF low interest rates
- As a result, MWD LRP revenue of \$250/AF not justified because IEUA overall costs of \$245/AF much lower than MWD current effective rate of \$798/AF

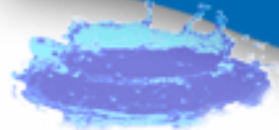

Clean, inexpensive, plentiful water

MWD Effective Rate Comparison to Agency Rate

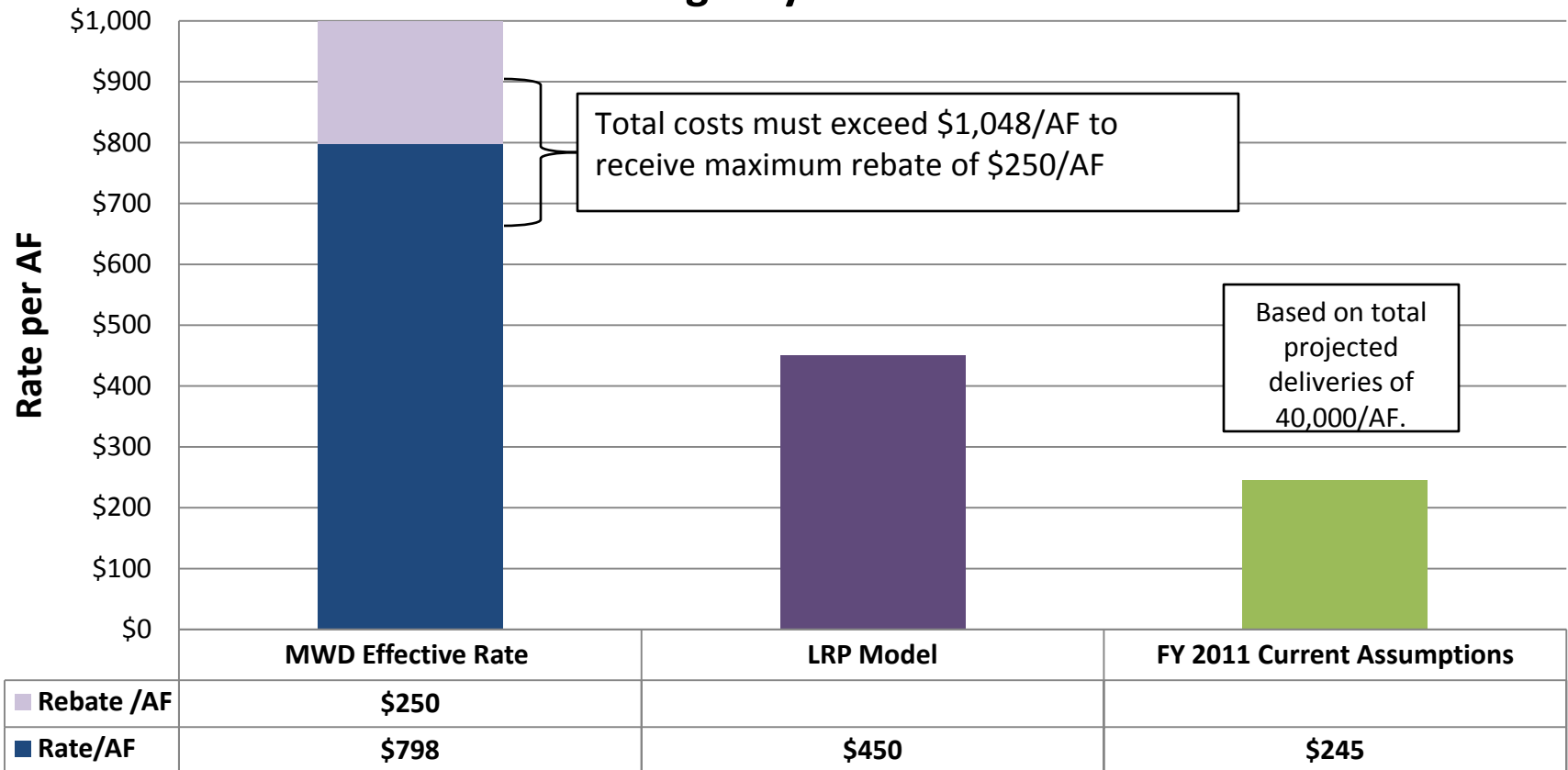



Clean, inexpensive, plentiful water

Recycled Water Rates:

Current rates \$75/AF plus \$10/AF surcharge for recharged

Projected Deliveries:

25,000 AF Direct + 15,000 AF Recharged= 40,000 AF

Description	FY 2010/11 (\$Millions)		
			Per AF
Recycled Water Sales	\$3.15		
MWD LPP Rebate, \$154/AF	2.10		
Total Sales Revenues		\$5.25	\$131
Less: Pumping Costs, \$50/AF Merged Agency Rate	(\$2.0)		
Less: O&M and Admin Expenses	(3.0)		
Less: Groundwater Recharge Expenses	(.8)		
Less: Debt Service Costs	(4.0)		



Clean, inexpensive, plentiful water

FY 2010/11 Total Estimated Costs

\$9.8 Million / 40,000 AF Total Deliveries = \$245/AF

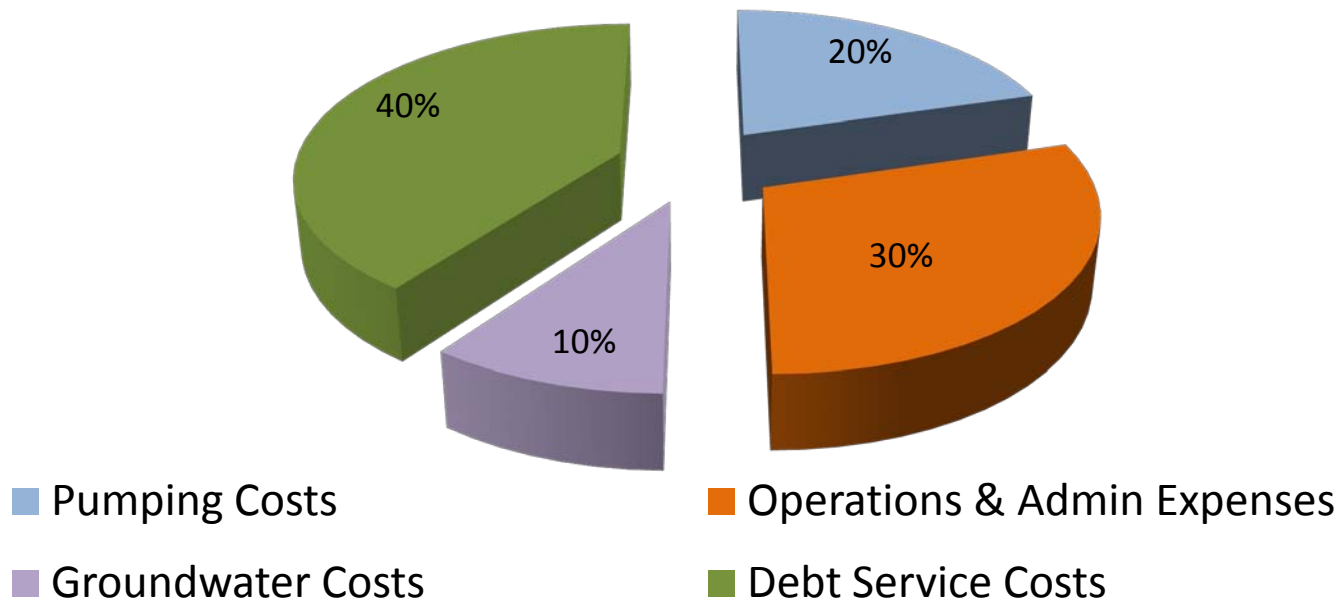

Estimated RW Pumping Costs - \$50/AF

- Projected RW Demand
 - GWR – 15,000 AF
 - Direct Use – 25,000 AF
- 8 RW Pump Stations
- Power Cost Assumption
 - \$0.12/kw-hr

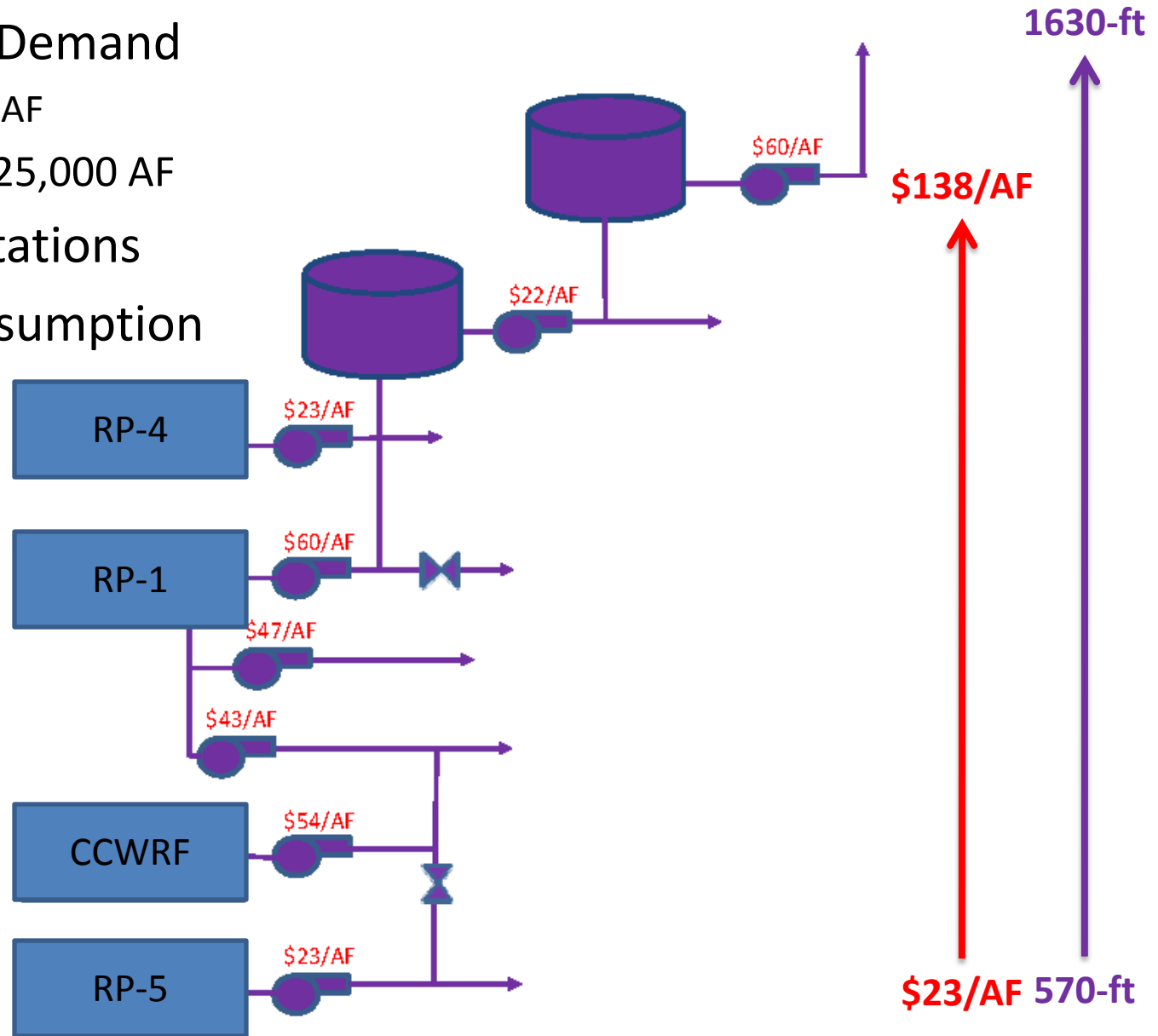

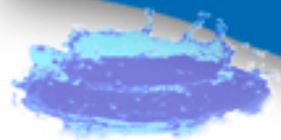

Clean, inexpensive, plentiful water

Recycled Water Projected O&M Costs

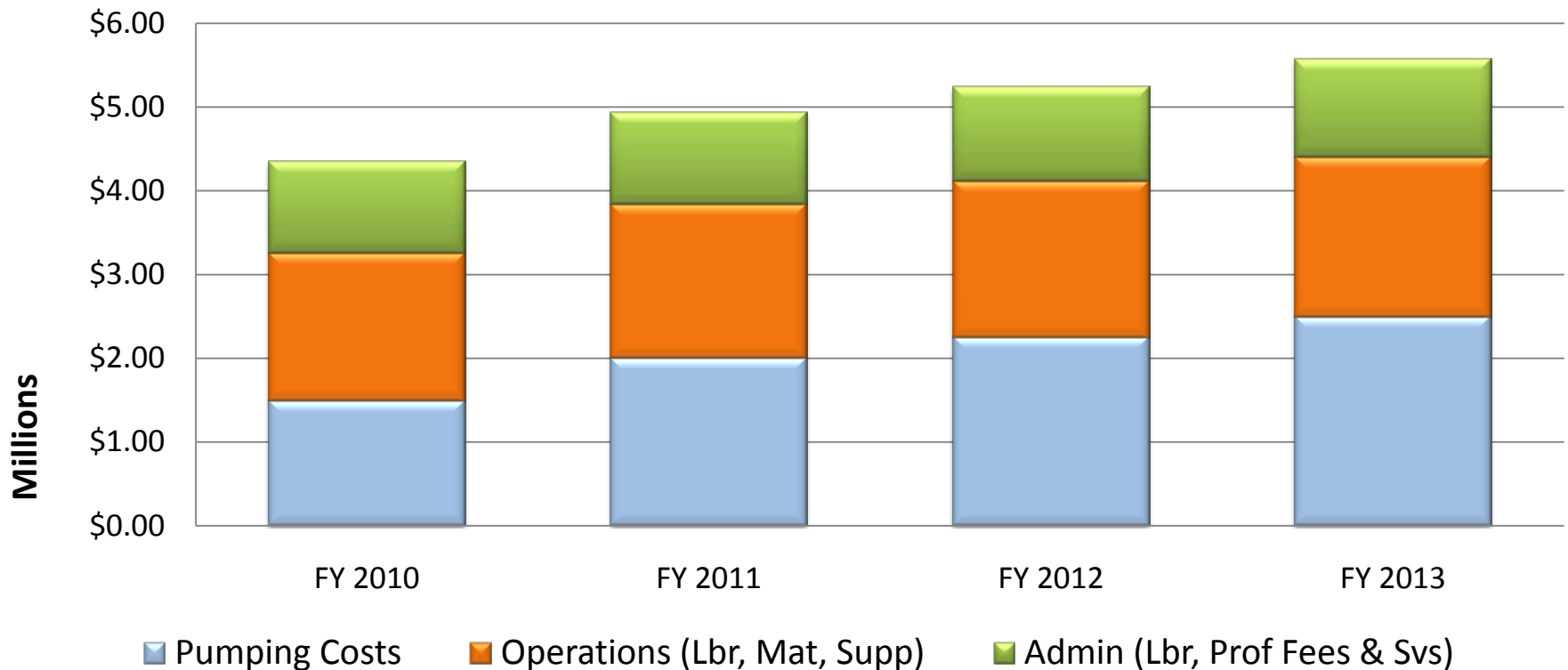

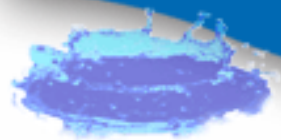

Clean, inexpensive, plentiful water

FY 2010/11 Total Groundwater Recharge Expenses

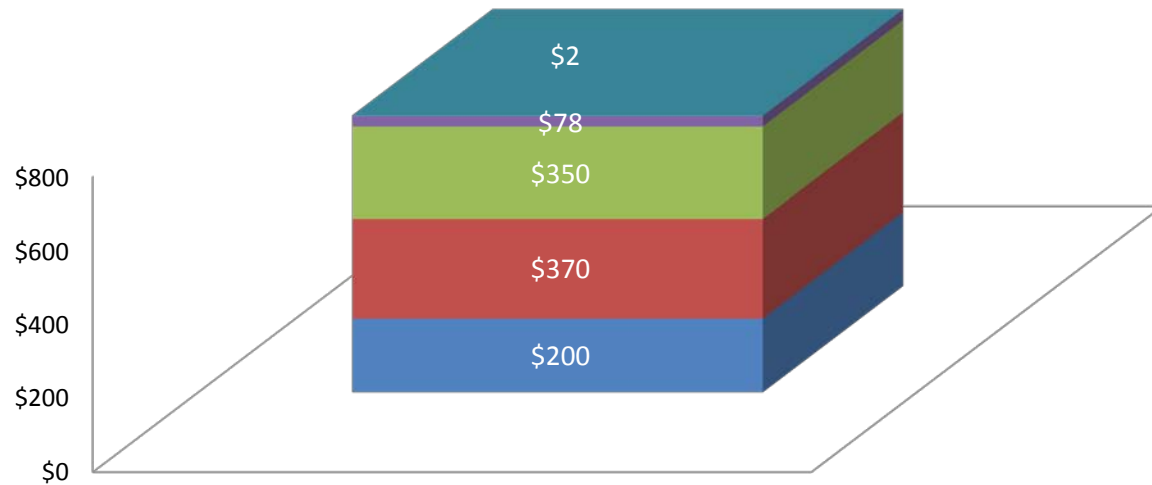

■ Peace 2 Agreement Agency Share ■ Laboratory ■ Sampling ■ Consulting ■ Administration

\$Thousands



Clean, inexpensive, plentiful water

FY 2010/11 Total Groundwater Recharge Expenses Funding Sources

Description	FY 2010/11
Total Estimated Groundwater Recharge Expenses	\$750,000
Less Current Funding Sources:	
\$10/AF Surcharge based on 15,000 AF recharged deliveries	(150,000)
Water Meter Service Charges	(300,000)
Unfunded Groundwater Recharge Expenses	\$300,000
Unfunded Expenses Per AF based on total deliveries of 15,000 AF for recharge	\$20.00



Clean, inexpensive, plentiful water

Recycled Water Operating Funding Options:

- 1) Increase Recycled Water Rate?
- 2) Meter Charges?
- 3) Other options?



Clean, inexpensive, plentiful water

Debt Service Payments:

- June 2009 Regional Committees/IEUA Board decided to use property taxes to pay recycled water debt service for the next three fiscal years: (FY 2010-FY 2013).
- Currently estimated at \$3.9 million for FY 2010/11.
- In the future will the debt service be funded by recycled water rates and charges, or other options:
 - *Continue property taxes?*
 - *Other fixed charges based on benefits to each agency?*

RECYCLED WATER RATE SURVEY – SOUTHERN CALIFORNIA AGENCIES

Wholesale Agencies			
Agency	Type	Notes	Rate \$/AF
Calleguas Municipal Water District	Wholesale	Base Rate	\$750
Central Basin Municipal Water District	Wholesale	Tiered Rates	\$ 275 - \$ 497
Eastern Municipal Water District	Wholesale	Tiered Rates	\$ 181 - \$ 288
Inland Empire Utilities Agency	Wholesale	Base Rate	\$75
Irvine Ranch Water District	Retail & Wholesale	Base Rate	\$449
MWD	Wholesale	Tiered Rate	\$0 - \$250
Orange County Water District	Wholesale	Green Acres rate	\$326
Upper San Gabriel Water District	Wholesale	Various Customer Agmnt	\$ 315- 360
West Basin Municipal Water District	Wholesale	Tiered Rates	\$ 501 - 1,195
Retail Agencies			
Agency	Type	Notes	Rate \$/AF
Burbank	Retail	Recycled Water Service	\$823
		School Recycled Water Service	\$414
City of Carlsbad	Retail	Base Rate	\$ 1,098
City of Escondido	Retail	Base Rate	\$ 976
Fallbrook Public UD	Retail	Base Rate	\$719
City of Glendale	Retail	Tiered Rates	\$238 - \$ 475
Las Virgenes Municipal Water District	Retail	Tiered Rates for Las Virgenes Valley Zone	\$818 - \$1,355
		Tiered Rates for Western / Calabasas Zone	\$510 - \$1,446
LA Dept of Water & Power	Retail	Tiered Rates	\$1,227 - \$1,913
Long Beach Water Department	Retail	Non Peaking – Peaking Rates	\$ 531 - \$ 744
Olivenhain Municipal WD	Retail	Base Rate	\$1,019
Otay Water District	Retail	Base Rate	\$1,124
City of Poway	Retail	Base Rate	\$1,294
Rincon Del Diablo MWD	Retail	Base Rate	\$897
City of San Diego	Retail	Base Rate	\$ 348
San Dieguito Water District	Retail	Base Rate	\$ 1,124
City of Santa Barbara	Retail	All Usage not applicable for irrigation	\$784
Sante Fe Irrigation District	Retail	Base Rate	\$ 1,133

RECYCLED WATER RATE SURVEY – IEUA Member Agency Rates

Member Agency	Rate \$/AF
Inland Empire Utilities Agency	Wholesale Base Rate: \$75
Chino	\$331.06
Chino Hills*	\$ 522.72
Cucamonga Valley Water District	\$487.87
Montclair (MVWD)	\$411.21
Ontario*	\$ 474.80

* Based on average of tiered rates from member agencies in Dec 09.



Inland Empire
UTILITIES AGENCY*
*A Municipal Water District

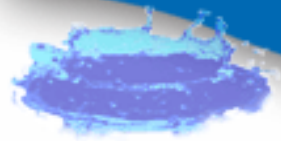

Clean, inexpensive, plentiful water

Questions?